

SIPMOS® Small-Signal Transistor

- N channel
- Enhancement mode
- Avalanche rated
- $V_{GS(th)} = 2.1 \dots 4.0 \text{ V}$
- Pb-free lead plating; RoHS compliant

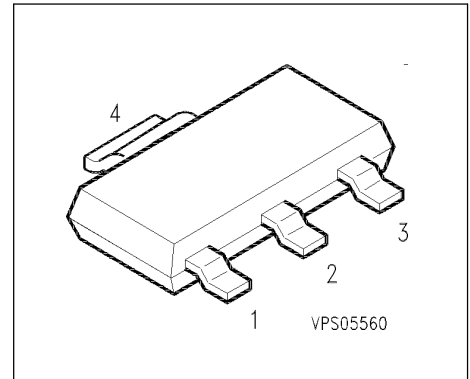
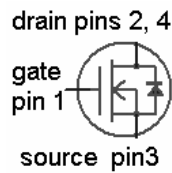

| | | | |
|-------|-------|-------|-------|
| Pin 1 | Pin 2 | Pin 3 | Pin 4 |
| G | D | S | D |

| Type | V_{DS} | I_D | $R_{DS(on)}$ | Package | Marking |
|---------|----------|-------|--------------|---------|---------|
| BSP 299 | 500 V | 0.4 A | 4 Ω | SOT-223 | BSP299 |

| Type | Pb-free | Tape and Reel Information |
|---------|---------|---------------------------|
| BSP 299 | Yes | L6327 |

Maximum Ratings

| Parameter | Symbol | Values | Unit |
|---|-------------|----------|------|
| Continuous drain current $T_A = 44 \text{ }^\circ\text{C}$ | I_D | 0.4 | A |
| DC drain current, pulsed $T_A = 25 \text{ }^\circ\text{C}$ | I_{Dpuls} | 1.6 | A |
| Avalanche energy, single pulse $I_D = 1.2 \text{ A}$, $V_{DD} = 50 \text{ V}$, $R_{GS} = 25 \text{ } \Omega$ $L = 163 \text{ mH}$, $T_j = 25 \text{ }^\circ\text{C}$ | E_{AS} | 130 | mJ |
| Gate source voltage | V_{GS} | ± 20 | V |
| Power dissipation $T_A = 25 \text{ }^\circ\text{C}$ | P_{tot} | 1.8 | W |

Maximum Ratings

| Parameter | Symbol | Values | Unit |
|--|------------|---------------|------|
| Chip or operating temperature | T_j | -55 ... + 150 | °C |
| Storage temperature | T_{stg} | -55 ... + 150 | |
| Thermal resistance, chip to ambient air | R_{thJA} | ≤ 70 | K/W |
| Thermal resistance, junction-soldering point ¹⁾ | R_{thJS} | ≤ 10 | |
| DIN humidity category, DIN 40 040 | | E | |
| IEC climatic category, DIN IEC 68-1 | | 55 / 150 / 56 | |

1) Transistor on epoxy pcb 40 mm x 40 mm x 1,5 mm with 6 cm² copper area for drain connection

Electrical Characteristics, at $T_j = 25^\circ\text{C}$, unless otherwise specified

| Parameter | Symbol | Values | | | Unit |
|-----------|--------|--------|------|------|------|
| | | min. | typ. | max. | |

Static Characteristics

| | | | | | |
|--|---------------|-----|-----------|----------|----|
| Drain- source breakdown voltage $V_{GS} = 0 \text{ V}$, $I_D = 0.25 \text{ mA}$, $T_j = 0^\circ\text{C}$ | $V_{(BR)DSS}$ | 500 | - | - | V |
| Gate threshold voltage $V_{GS} = V_{DS}$, $I_D = 1 \text{ mA}$ | $V_{GS(th)}$ | 2.1 | 3 | 4 | |
| Zero gate voltage drain current $V_{DS} = 500 \text{ V}$, $V_{GS} = 0 \text{ V}$, $T_j = 25^\circ\text{C}$ $V_{DS} = 500 \text{ V}$, $V_{GS} = 0 \text{ V}$, $T_j = 125^\circ\text{C}$ | I_{DSS} | - | 0.1 10 | 1 100 | μA |
| Gate-source leakage current $V_{GS} = 20 \text{ V}$, $V_{DS} = 0 \text{ V}$ | I_{GSS} | - | 10 | 100 | |
| Drain-Source on-state resistance $V_{GS} = 10 \text{ V}$, $I_D = 0.4 \text{ A}$ | $R_{DS(on)}$ | - | 3.5 | 4 | Ω |

Electrical Characteristics, at $T_j = 25^\circ\text{C}$, unless otherwise specified

| Parameter | Symbol | Values | | | Unit |
|-----------|--------|--------|------|------|------|
| | | min. | typ. | max. | |

Dynamic Characteristics

| | | | | | |
|--|--------------|-----|-----|-----|----|
| Transconductance $V_{DS} \geq 2 \cdot I_D \cdot R_{DS(on)max}, I_D = 0.4 \text{ A}$ | g_{fs} | 0.3 | 1.2 | - | S |
| Input capacitance $V_{GS} = 0 \text{ V}, V_{DS} = 25 \text{ V}, f = 1 \text{ MHz}$ | C_{iss} | - | 300 | 400 | pF |
| Output capacitance $V_{GS} = 0 \text{ V}, V_{DS} = 25 \text{ V}, f = 1 \text{ MHz}$ | C_{oss} | - | 40 | 60 | |
| Reverse transfer capacitance $V_{GS} = 0 \text{ V}, V_{DS} = 25 \text{ V}, f = 1 \text{ MHz}$ | C_{rss} | - | 15 | 25 | |
| Turn-on delay time $V_{DD} = 30 \text{ V}, V_{GS} = 10 \text{ V}, I_D = 0.3 \text{ A}$ $R_{GS} = 50 \Omega$ | $t_{d(on)}$ | - | 8 | 12 | ns |
| Rise time $V_{DD} = 30 \text{ V}, V_{GS} = 10 \text{ V}, I_D = 0.3 \text{ A}$ $R_{GS} = 50 \Omega$ | t_r | - | 15 | 22 | |
| Turn-off delay time $V_{DD} = 30 \text{ V}, V_{GS} = 10 \text{ V}, I_D = 0.3 \text{ A}$ $R_{GS} = 50 \Omega$ | $t_{d(off)}$ | - | 55 | 70 | |
| Fall time $V_{DD} = 30 \text{ V}, V_{GS} = 10 \text{ V}, I_D = 0.3 \text{ A}$ $R_{GS} = 50 \Omega$ | t_f | - | 30 | 40 | |

Electrical Characteristics, at $T_j = 25^\circ\text{C}$, unless otherwise specified

| Parameter | Symbol | Values | | | Unit |
|-----------|--------|--------|------|------|------|
| | | min. | typ. | max. | |

Reverse Diode

| | | | | | |
|--|----------|---|-----|-----|---------------|
| Inverse diode continuous forward current $T_A = 25^\circ\text{C}$ | I_S | - | - | 0.4 | A |
| Inverse diode direct current,pulsed $T_A = 25^\circ\text{C}$ | I_{SM} | - | - | 1.6 | |
| Inverse diode forward voltage $V_{GS} = 0\text{ V}, I_F = 0.8\text{ A}, T_j = 25^\circ\text{C}$ | V_{SD} | - | 0.9 | 1.2 | V |
| Reverse recovery time $V_R = 100\text{ V}, I_F = I_S, di_F/dt = 100\text{ A}/\mu\text{s}$ | t_{rr} | - | 300 | - | ns |
| Reverse recovery charge $V_R = 100\text{ V}, I_F = I_S, di_F/dt = 100\text{ A}/\mu\text{s}$ | Q_{rr} | - | 2.5 | - | μC |

Power dissipation

$$P_{\text{tot}} = f(T_A)$$

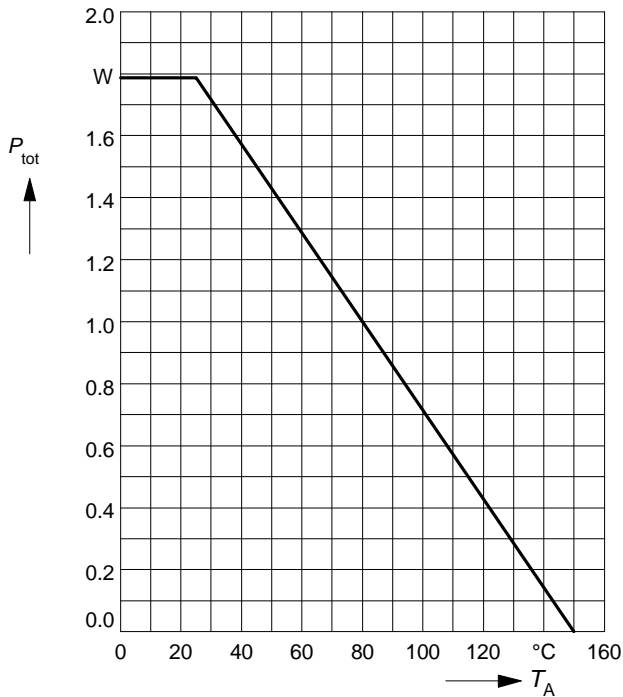

Drain current

$$I_D = f(T_A)$$

parameter: $V_{GS} \geq 10 \text{ V}$

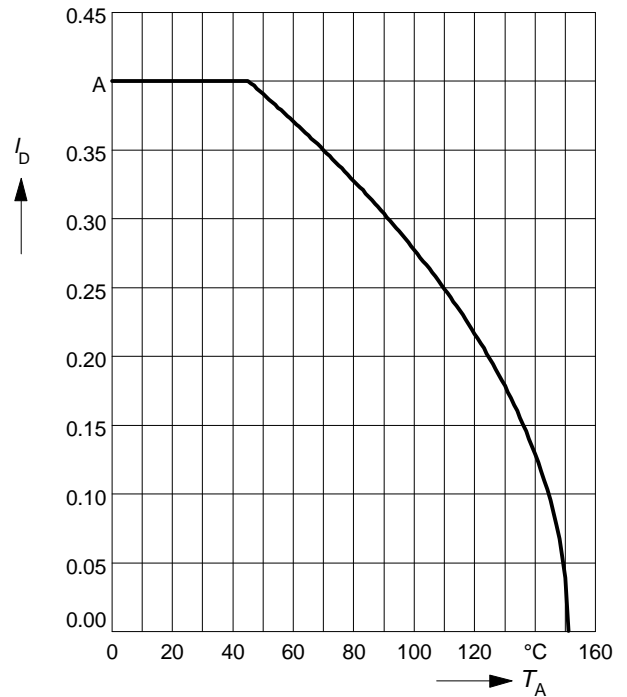

Safe operating area $I_D = f(V_{DS})$

parameter: $D = 0, T_C = 25^\circ\text{C}$

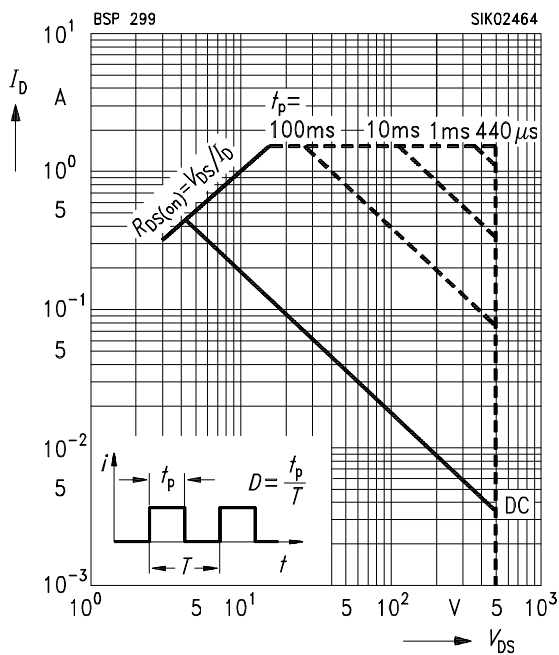

Transient thermal impedance

$$Z_{\text{thJA}} = f(t_p)$$

parameter: $D = t_p / T$

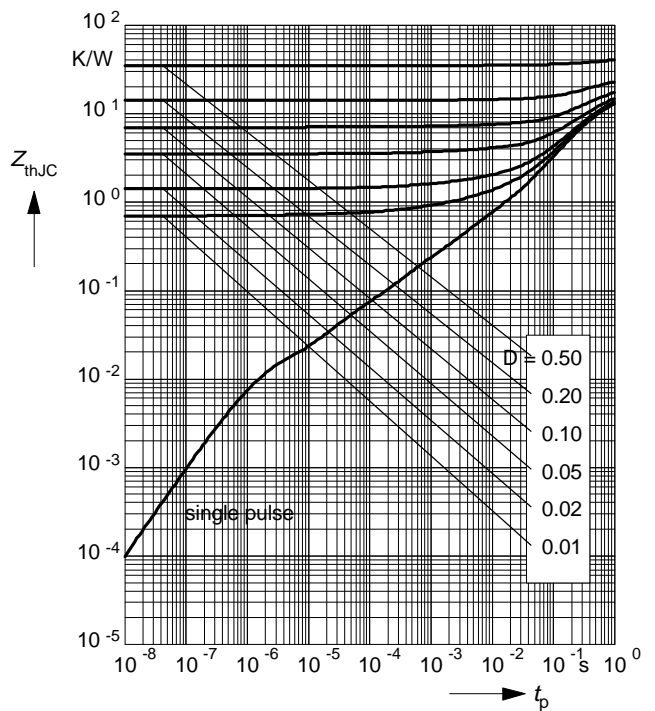

Typ. output characteristics

$$I_D = f(V_{DS})$$

parameter: $t_p = 80 \mu s$, $T_j = 25 \text{ }^\circ\text{C}$

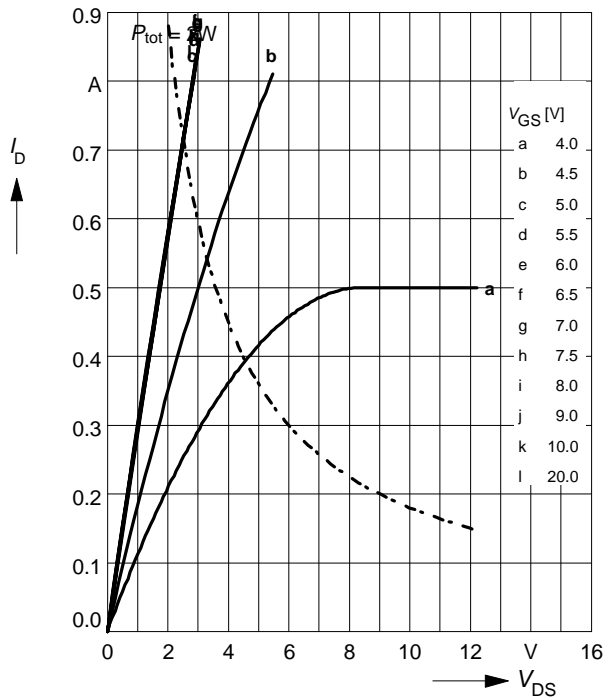

Typ. drain-source on-resistance

$$R_{DS(on)} = f(I_D)$$

parameter: $t_p = 80 \mu s$, $T_j = 25 \text{ }^\circ\text{C}$

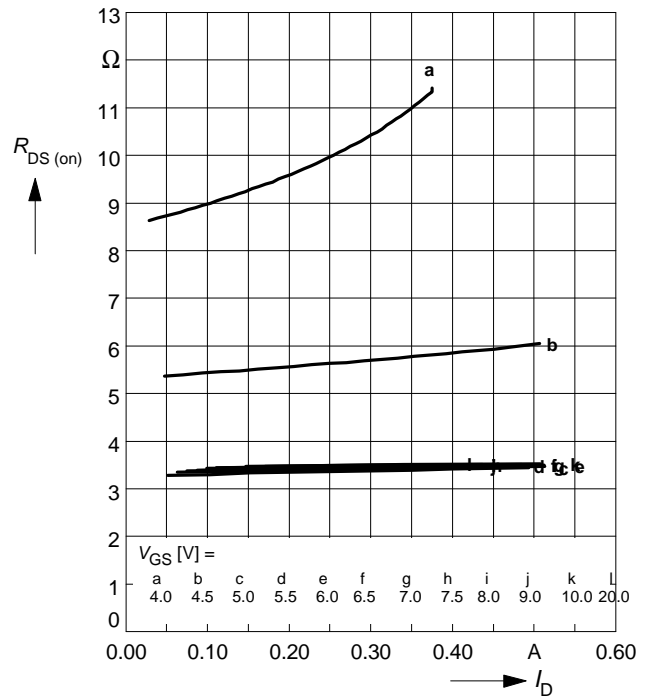

Typ. transfer characteristics $I_D = f(V_{GS})$

parameter: $t_p = 80 \mu s$

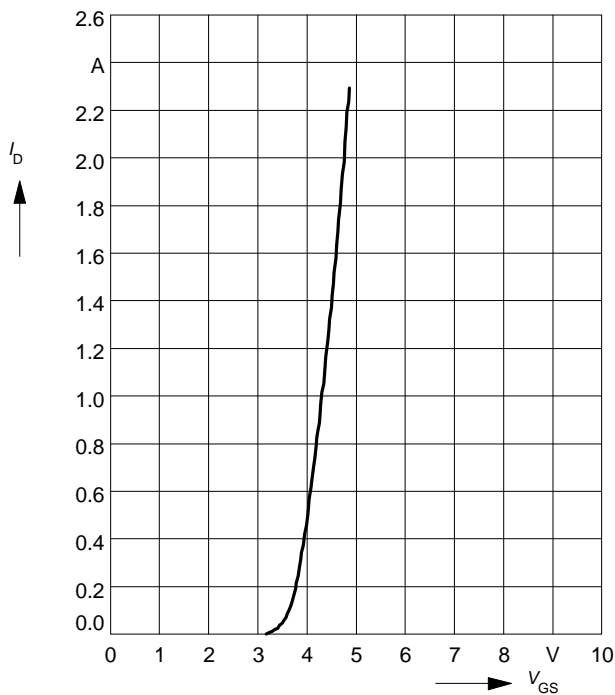

Typ. forward transconductance $g_{fs} = f(I_D)$

parameter: $t_p = 80 \mu s$,

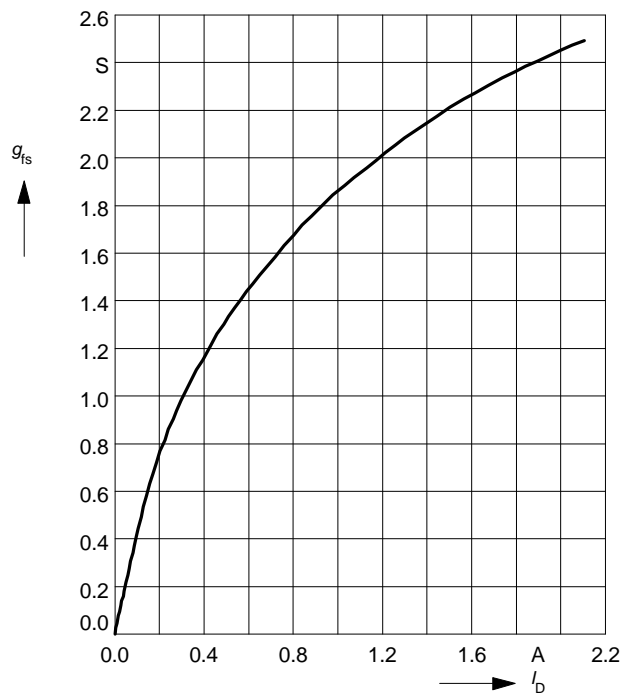

Drain-source on-resistance

$$R_{DS(on)} = f(T_j)$$

parameter: $I_D = 0.4 \text{ A}$, $V_{GS} = 10 \text{ V}$

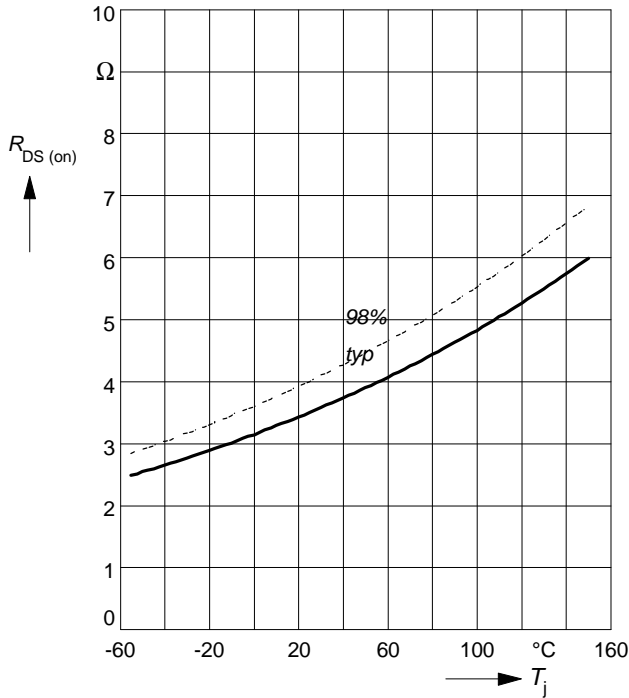

Gate threshold voltage

$$V_{GS(th)} = f(T_j)$$

parameter: $V_{GS} = V_{DS}$, $I_D = 1 \text{ mA}$

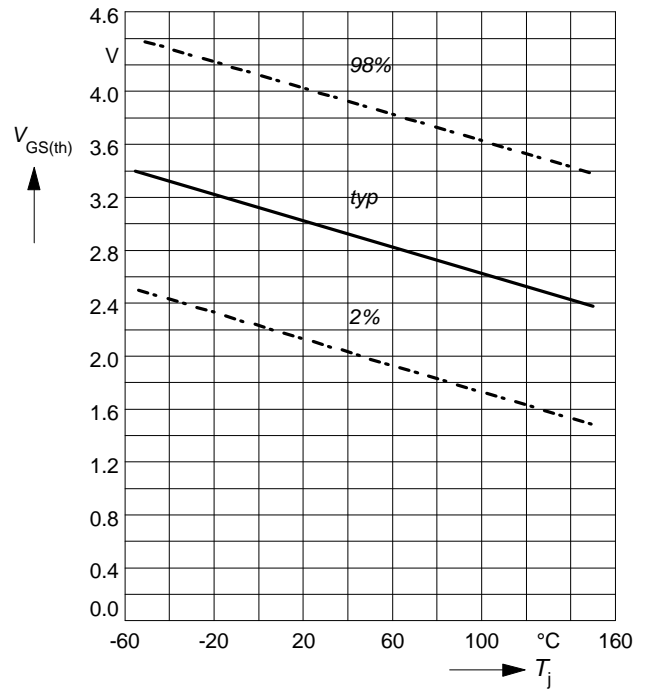

Typ. capacitances

$$C = f(V_{DS})$$

parameter: $V_{GS} = 0 \text{ V}$, $f = 1 \text{ MHz}$

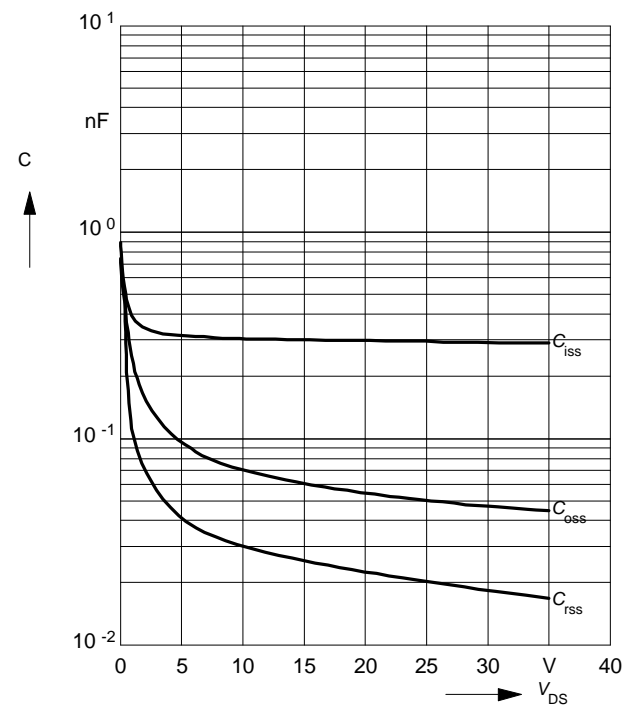

Forward characteristics of reverse diode

$$I_F = f(V_{SD})$$

parameter: T_j , $t_p = 80 \mu\text{s}$

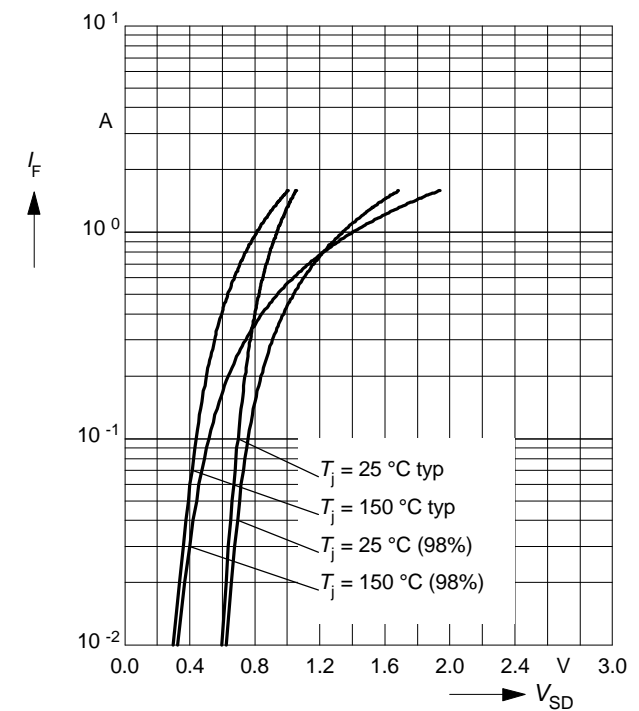

Avalanche energy $E_{AS} = f(T_j)$

parameter: $I_D = 1.2 \text{ A}$, $V_{DD} = 50 \text{ V}$

$R_{GS} = 25 \Omega$, $L = 163 \text{ mH}$

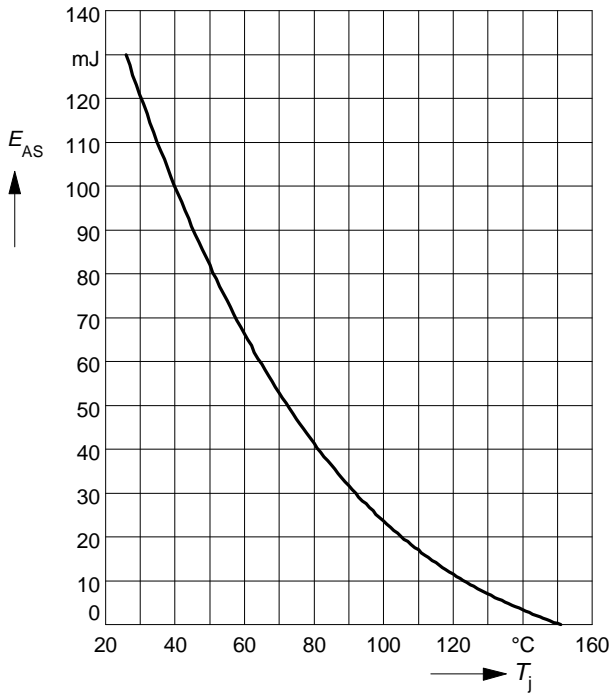

Drain-source breakdown voltage $V_{(BR)DSS} = f(T_j)$

$V_{(BR)DSS} = f(T_j)$

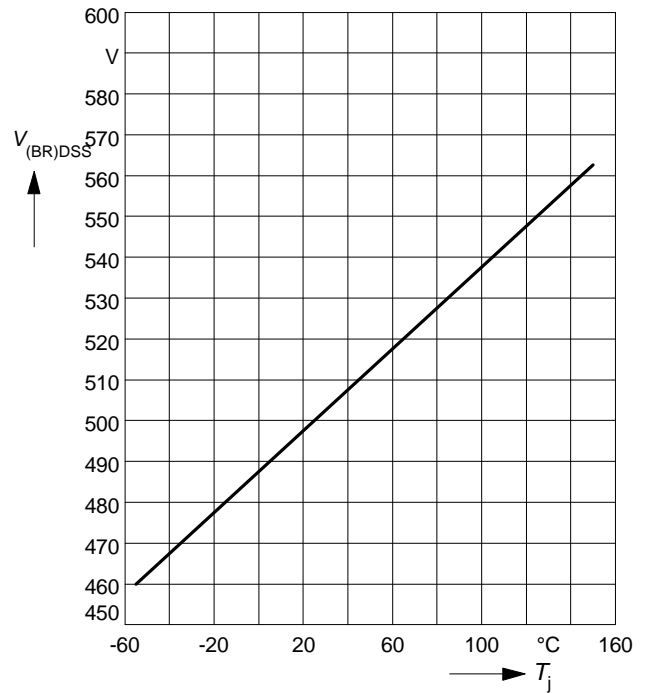

Safe operating area $I_D = f(V_{DS})$

parameter: $D = 0.01$, $T_C = 25^\circ\text{C}$

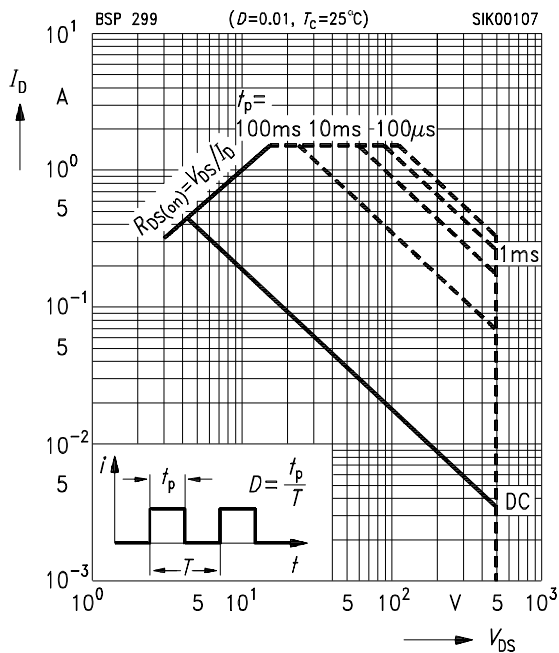

Package outlines

SOT-223

Dimensions in mm

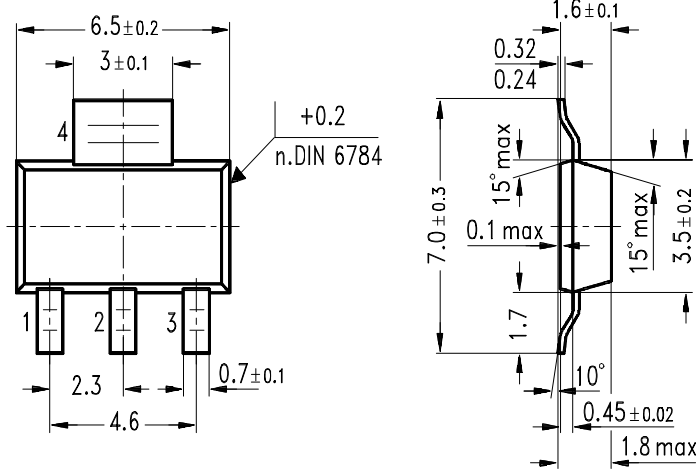

GPS05560